



MASERATI

OFFICIAL LICENSED PRODUCT

*Maserati logo and model designations are registered trademark of exclusive propriety of Maserati S.p.A. Under license o Maserati S.p.A. All rights reserved.*

Powered by Segway

The manufacturer reserves the right to make changes to the product, release firmware updates, and update this manual at any time. Visit [www.segway.com](http://www.segway.com) or check the Segway-Ninebot App to download the latest user materials. You must install the App, activate your KickScooter, and obtain the latest updates and safety instructions.

[ap-en.segway.com](http://ap-en.segway.com)

CE.00.0049.27-A

## User Manual



MASERATI

**ME** e-Scooter

Please read the user manual carefully before riding and keep it for reference.

## Contents

1 Riding Safety	02
2 Packing List	04
3 Diagram	05
4 Assembling Your KickScooter	06
5 Activate the KickScooter	07
6 Charging	08
7 Learning to Ride	08
8 Warnings	10
9 Folding and Carrying	14
10 Maintenance	15
11 Specifications	17
12 Trademark and Legal Statement	18
13 Contact	19

Original Instructions

## Welcome

Thanks for choosing the Maserati MC-eScooter (referred to as KickScooter)!

Your KickScooter is a recreational product with a mobile app, allowing you to connect with other riders.

Enjoy your ride and connect with riders worldwide!



The pictures shown are for illustration purposes only. The actual product may vary.

# 1 Riding Safety

1. The KickScooter is a recreational product. Before mastering riding skills, you need to practice. Neither Ninebot Inc. (means Ninebot (Beijing) Tech Co., Ltd. and its subsidiaries and affiliates) nor Segway Inc. is responsible for any injuries or damage caused by a rider's inexperience or failure to follow the instructions in this document.
  2. Please understand that you can reduce the risk by following all the instructions and warnings in this manual, but you cannot eliminate all the risks. Remember that whenever you ride the KickScooter you risk injury from loss of control, collisions, and falls. When entering into public spaces always comply with the local laws and regulations. As with other vehicles, faster speeds require longer braking distance. Sudden braking on low traction surfaces could lead to wheel slip, or falls. Be cautious and always keep a safe distance between you and other people or vehicles when riding. Be alert and slow down when entering unfamiliar areas.
  3. Always wear a helmet when riding. Use an approved bicycle or skateboard helmet that fits properly with the chin strap in place, and provides protection for the back of your head.
  4. Do not attempt your first ride in any area where you might encounter children, pedestrians, pets, vehicles, bicycles, or other obstacles and potential hazards.
  5. Respect pedestrians by always yielding the right of way. Pass on the left whenever possible. When approaching a pedestrian from the front, stay to the right and slow down. Avoid startling pedestrians. When approaching from behind, announce yourself and slow down to walking speed when passing. Please obey local traffic laws and regulations if the situation is different.
  6. In places without laws comply with the safety guidelines outlined in this manual. Neither Ninebot Inc. nor Segway Inc. is responsible for any property damage, personal injury/death, accidents, or legal disputes caused by violations of the safety instructions.
  7. Do not allow anyone to ride your KickScooter on his/her own unless they have carefully read this manual. The safety of new riders is your responsibility. Assist new riders until they are comfortable with the basic operation of the KickScooter. Make sure each new rider wears a helmet and other protective gear.
  8. Before each ride check for loose fasteners and damaged components. If the KickScooter makes abnormal sounds or signals an alarm, immediately stop riding. Diagnose your KickScooter via the Segway-Ninebot App and call your dealer/distributor for service.
  9. Be alert! Scan both far ahead and in front of your KickScooter — your eyes are your best tool for safely avoiding obstacles and low traction surfaces (including, but not limited to, wet ground, loose sand, loose gravel, and ice).
  10. To reduce the risk of injury, you must read and follow all "CAUTION" and "WARNING" notices in this document. Do not ride at an unsafe speed. Under no circumstance should you ride on roads with motor vehicles. The manufacturer recommends riders be 14+ years old. Always follow these safety instructions:
    - A. People who should not ride the KickScooter include:
      - i. Anyone under the influence of alcohol or drugs.
      - ii. Anyone who suffers from a disease that puts them at risk if they engage in strenuous physical activity.
      - iii. Anyone who has problems with balance or with motor skills that would interfere with their ability to maintain balance.
      - iv. Anyone whose weight is outside the stated limits (see Specifications).
      - v. Pregnant women.
    - B. Riders under the age of 18 years old should ride under adult supervision.
    - C. Comply with local laws and regulations when riding this product. Do not ride where prohibited by local laws.
    - D. To ride safely, you must be able to see what is in front of you and you must be clearly visible to others.
    - E. Do not ride in the snow, in the rain, or on roads which are wet, muddy, icy, or that are slippery for any reason. Do not ride over obstacles (sand, loose gravel, or sticks). Doing so could result in a loss of balance or traction and could cause a fall.
11. Do not attempt to charge your KickScooter if, the charger or the power outlet is wet.
  12. As with any electronic device, use a surge protector when charging to help protect your KickScooter from damage due to power surges and voltage spikes. Only use the Segway supplied charger. Do not use a charger from any other different product models.
  13. Use only Ninebot or Segway approved parts and accessories. Do not modify your KickScooter. Modifications to your KickScooter could interfere with the operation of the KickScooter, could result in serious injury and/or damage, and could void the Limited Warranty.
  14. Children should not play with the KickScooter or parts of it nor should cleaning or maintenance be done by children. The use of the machine results in the transmission of vibrations throughout the driver's body.
  15. Always place the KickScooter on its stand on a flat and stable surface. The KickScooter must be placed with the stand against the slope to prevent it from tipping over. Never place the KickScooter with the front facing down the slope, as the stand may close and tip the machine. Once the KickScooter is on its stand, check its stability to avoid any risk of falling (by slip, wind or slight jolt). Do not park the KickScooter in a busy area, but rather along a wall. If possible, always choose to park your KickScooter on flat ground.
  16. For a better driving experience, it is recommended to conduct regular maintenance of the product.
  17. Please read the user manual before charging the battery.
  18. Do not touch the brake system, it could cause injuries.

## 2 Packing List

### Assembled KickScooter

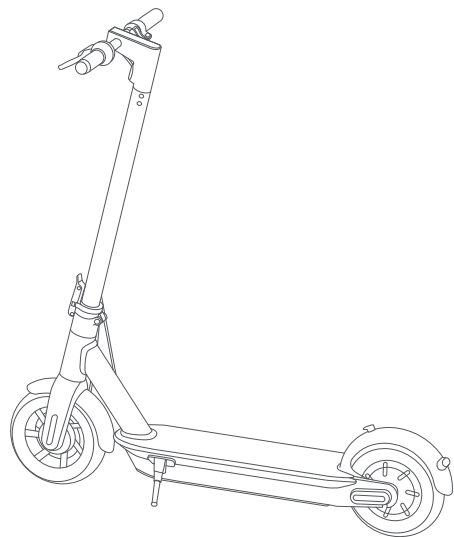

### User Materials



### Accessories

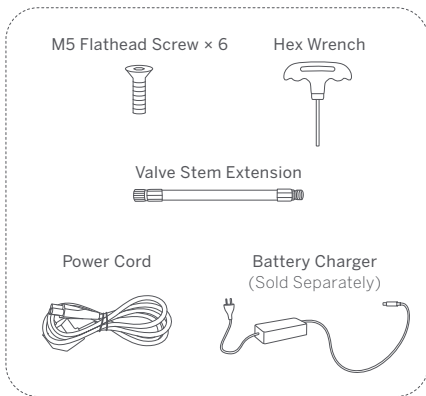

When unpacking your KickScooter, please verify that the above items are included in the package. If you are missing any components, please contact your dealer/distributor or nearest service center (see Contact in the user manual). After verifying that all components are present and in good condition, you can assemble your new KickScooter.

Please retain the box and packaging materials in case you need to ship your KickScooter in the future.

Remember to power off your KickScooter and unplug the power cord before assembling, mounting accessories, or cleaning the mainframe.

## 3 Diagram

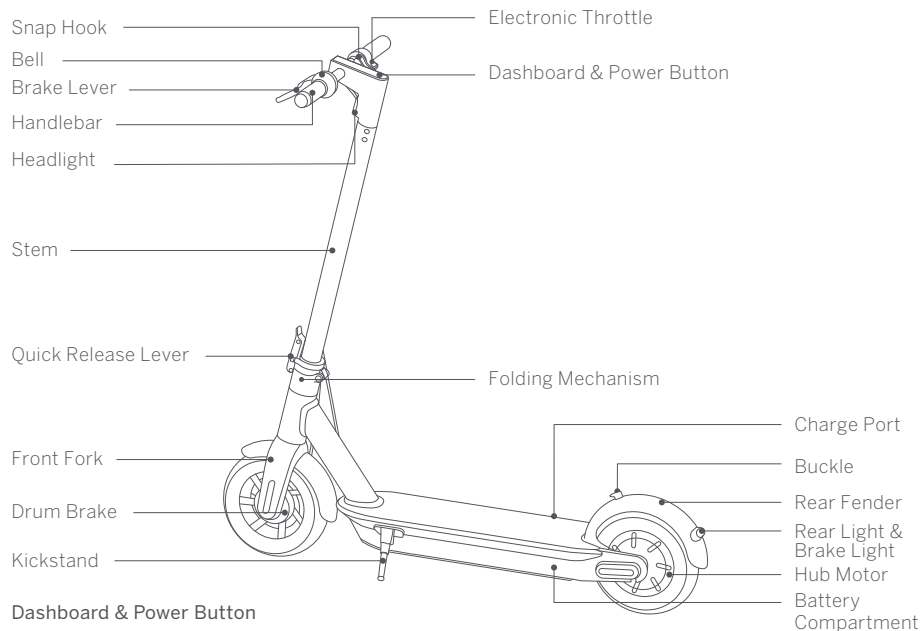

### Dashboard & Power Button

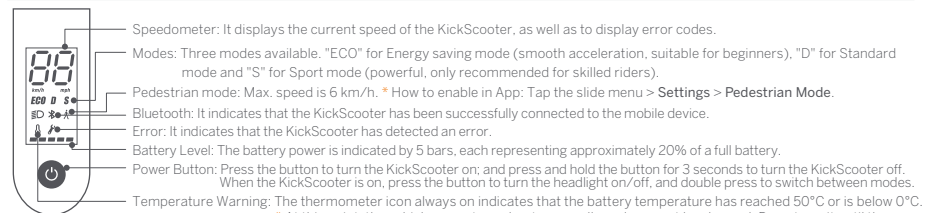

\* At this point, the vehicle cannot accelerate normally and may not be charged. Do not use it until the temperature has reverted to the normal range.

## 4 Assembling Your KickScooter

- 1 Unfold the handlebar stem and fasten it. Then unfold the kickstand to support the KickScooter.

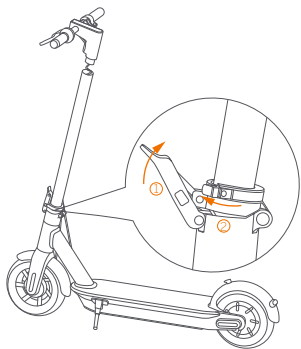

- 3 Install six screws (two on each side) with the included hex wrench.

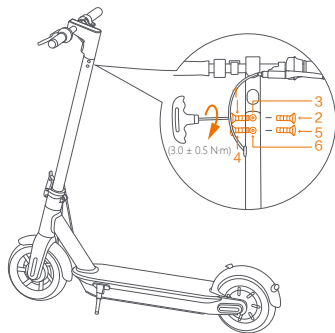

- 2 Slide the handlebar onto the stem with a headlight facing the front.

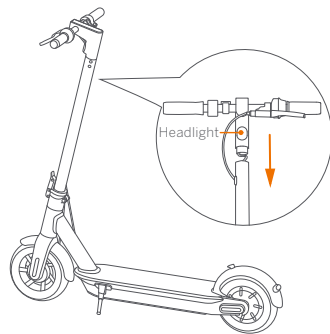

- 4 Verify that your KickScooter can be powered on and off.

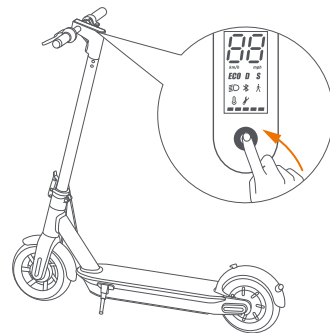

## 5 Activate the KickScooter



Segway-Ninebot App

⚠ There are safety risks when learning to ride the KickScooter. You must read the Riding Safety via the App before your first ride.

For your safety, your new KickScooter is not activated and will beep occasionally after Power ON.

Until activated, the KickScooter maintains very low riding speed, and cannot be ridden with full function.

- 1 Install the App and register/log in.

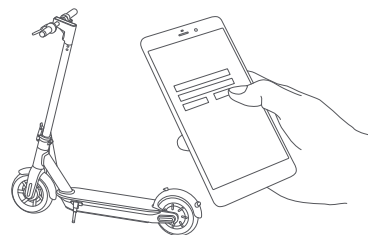

- 2 Power on the KickScooter.

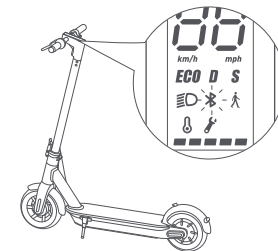

- 3 Click "Vehicle" → "Search vehicle" to connect to your KickScooter.

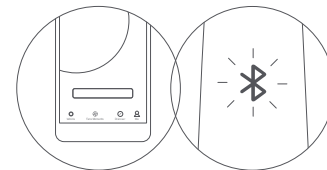

- 4 Follow the App instructions to activate the KickScooter and learn how to ride safely. You can now start to use your KickScooter, check the status with App, and interact with other users. Have fun!

## 6 Charging

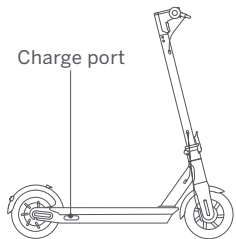

### Charging step tips



Open the charge port cover.



Insert the charge plug.



Close the charge port cover when finished.

### ▲ WARNING

Do not charge if the charge port or power cord is wet.

Do not charge or use your battery if it is damaged or see a trace of water.

Close the charge port cover when not charging.

## 7 Learning to Ride



Wear an approved helmet and other protective gear to minimize any possible injury.

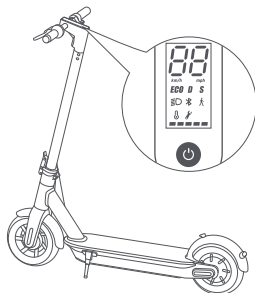

- 1 Power on the KickScooter and check the battery level. Charge the KickScooter if the battery level is low.

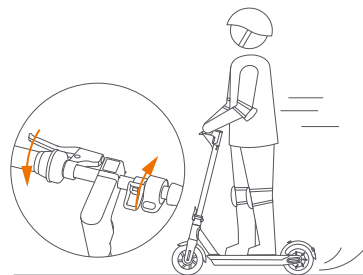

- 4 Slow down by releasing the throttle; and brake by squeezing the brake lever.

### ▲ WARNING

When hard braking, you risk serious injury due to loss of traction and falls. Maintain a moderate speed and look out for potential hazards.

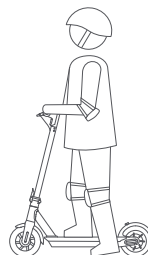

- 2 Stand on the footrest with one foot and push off with another foot to start gliding.

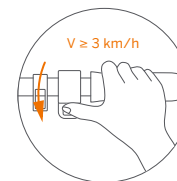

- 3 Put your other foot on the footrest to keep both feet stable. Press the throttle on the right hand to speed up when you are balanced.  
Note, for your safety, the motor will not engage until the KickScooter reaches 3 km/h.

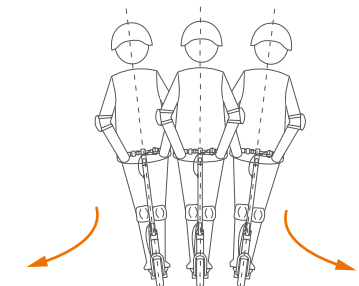

- 5 To turn, shift your body weight and turn the handle slightly.

## 8 Warnings

**⚠ WARNING**  
Failure to follow these instructions could lead to serious injury.



**⚠** DO NOT ride the KickScooter in the rain. DO NOT get wet.

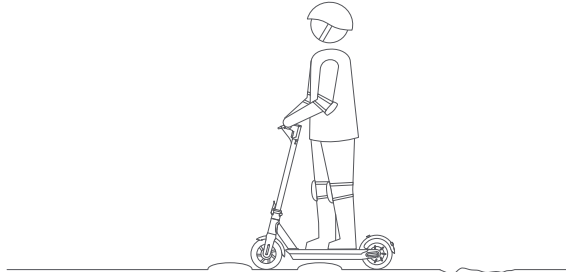

**⚠** Keep your speed between 5–10 km/h when you ride through speed bumps, elevator door stills, bumpy roads or other uneven surfaces. Slightly bend your knee to better adjust mentioned surfaces.

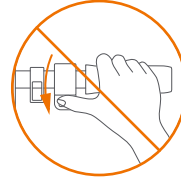

**⚠** DO NOT press the throttle when walking with the KickScooter.



**⚠** Avoid contacting obstacles with the tire/wheel.

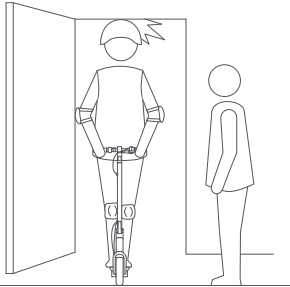

**⚠** Watch your head when passing through doorways.

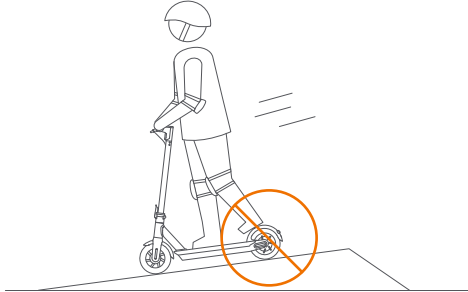

**⚠** Do not keep your feet on the rear fender.

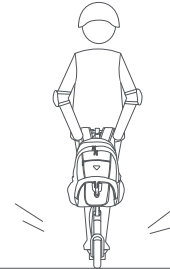

**⚠** DO NOT carry heavy objects on the handlebar.

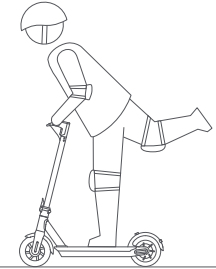

**⚠** DO NOT ride the KickScooter with only one foot.

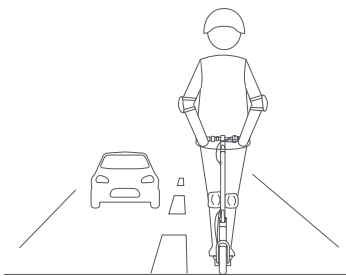

⚠ DO NOT ride on public roads, motorways, or highways.

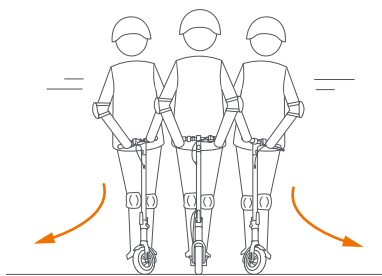

⚠ DO NOT rotate the handle violently while driving at high speed.

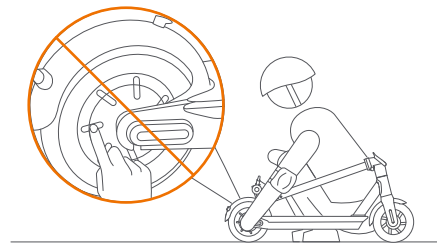

⚠ DO NOT touch the hub motor after riding because it can get hot.



⚠ DO NOT take your hands off the handlebar while riding. Do not ride with one hand only.



⚠ DO NOT ride through puddles or any other (water) obstacles. In such a case please lower your speed and bypass the obstacle.

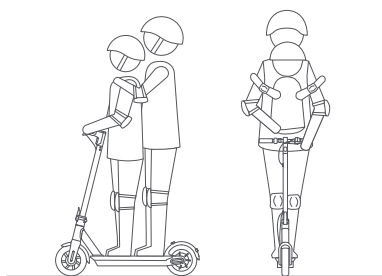

⚠ The KickScooter is for one rider only. Do not carry any passengers. Do not carry a child. Do not ride when pregnant.

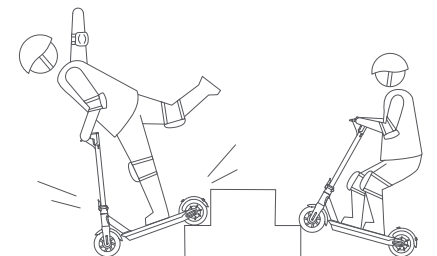

⚠ DO NOT ride up and down stairs or jump over obstacles.



⚠ DO NOT use a mobile phone or wear earphones when operating the KickScooter.

**⚠ WARNING**  
Always keep both hands on the handlebar or you risk serious injury due to loss of balance and falls.



## 9 Folding and Carrying

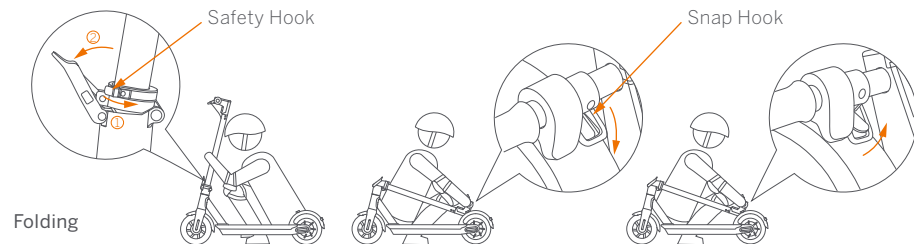

### Folding

Power off your KickScooter. Turn the safety hook counterclockwise and open the quick release lever.

Align the snap hook and the buckle and hook them.

Disengage the snap hook from the buckle. Fold the handlebar stem up, close the quick release lever and turn the safety hook clockwise.

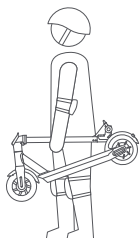

### Carrying

When your KickScooter is folded up, lift it by the stem to carry.

## 10 Maintenance

### Cleaning and Storage

Use a soft, wet cloth to wipe the mainframe clean. Dirt hard to remove can be scrubbed with a toothbrush and toothpaste, then cleaned with a soft, wet cloth.

### NOTE

Do not wash your KickScooter with alcohol, gasoline, acetone, or other corrosive/volatile solvents. These substances may damage the appearance and internal structure of your KickScooter. Do not wash your KickScooter with a power washer or hose.

### ⚠ WARNING

Make sure the KickScooter is powered OFF, the power cord is unplugged, and the rubber cap on the charge port is tightly sealed before cleaning; otherwise you may damage the electronic components.

Store your KickScooter in a cool, dry place. Do not store it outdoors for extended periods. Exposure to sunlight and temperature extremes (both hot and cold) will accelerate the aging process of the plastic components and may reduce battery life.

### Tire Pressure

Inflate tires to 32–37 psi. Inflate both tires equally.

### Battery Maintenance

#### ⚠ WARNING

- Only use the original battery by the manufacturer.
- DO NOT store or charge the battery at temperatures outside the stated limits (see Specifications).
- DO NOT puncture the battery. DO NOT attempt to disassemble the battery. DO NOT touch battery contacts. DO NOT dismantle or puncture the casing.
- Keep the battery contacts away from metal objects to prevent short circuit. Risk of fire. No user serviceable parts.
- DO NOT charge or use your battery if it is damaged or see a trace of water.
- DO NOT store or charge the battery at temperatures outside the stated limits (see Specifications). DO NOT expose the battery to fire. DO NOT discard or destroy the battery.
- Charge the battery after each ride and avoid draining the battery completely. Please read the user manual before charging the battery.
- Refer to your local laws and regulations regarding battery recycling and/or disposal.

## NOTE

A well maintained battery can perform well even after many miles of riding. Charge the battery after each ride and avoid draining the battery completely. When used at room temperature (70°F [22°C]) the battery range and performance is at its best; whereas using it at temperatures below 32°F (0°C) can decrease range and performance. Typically, at -4°F (-20°C) range can be half that of the same battery at 70°F (22°C). Battery range will recover when temperature rises. More details are available in the App.

Typically, a fully charged battery should retain power for 120-180 days. A low-power battery should retain power for 30-60 days. Remember to charge the battery after each use. Completely draining the battery may cause permanent damage to the battery. Electronics inside the battery record the charge-discharge condition of the battery; damage caused by over-charging or under-charging will not be covered by the Limited Warranty.

## ⚠ WARNING

Do not ride when the ambient temperature is outside the machine operation temperature (see Specifications) because low/high temperature will limit the maximum power/torque. Doing so could cause personal injury or property damage due to slips or falls.

## 11 Specifications

	Item	Parameters
Product	Name	Maserati MC-eScooter
	Model	G30M
	Length x Width x Height	Approx. 1167 × 472 × 1203 mm
	Folded: Length x Width x Height	Approx. 1167 × 472 × 534 mm
	Net Weight	Approx. 19.8 kg
Rider	Payload	30-120 kg
	Recommended Age	14-60 years
	Required Height	120-200 cm
Machine Parameters	Max. Speed	Approx. 25 km/h
	0-25 km/h Acceleration Time	10 sec
	Typical Range <sup>[1]</sup>	Approx. 65 km
	Max. Slope	Approx. 21% (12°)
	Traversable Terrain	asphalt/flat pavement; obstacles < 1 cm; gaps < 3 cm
	Operating Temperature	-10-40°C
	Storage Temperature	-20-50°C
	IP Rating	IPX5
	Duration of Charging	Approx. 6 h
Battery	Nominal Voltage	36 VDC
	Max. Charging Voltage	42 VDC
	Charging Temperature	0-40°C
	Nominal Energy	551 Wh
	Nominal Capacity	15.3 Ah
	Battery Management System	Over-heating, short circuit, over-current and over-charge protection
Motor	Nominal Power	400 W
	Output Power	121 W
Charger	Input Voltage	100-240 V ~
	Output Voltage	42 VDC
	Output Current	2.9 A
	Brake Light	LED rear light
Features	Riding Modes	Energy Saving mode, Standard mode and Sport mode
	Tires	10-inch tubeless tire
Tire	Tire Pressure	32-37 psi

[1] Typical Range: tested while riding under full power, 75 kg load, 25°C, 60% of max. speed on average on pavement.

\* Some of the factors that affect range include speed, number of starts and stops, ambient temperature, etc.

## 12 Trademark and Legal Statement

Segway and the Rider Design are registered trademarks of Segway Inc., Ninebot is a registered trademark of Ninebot (Tianjin) Tech Co., Ltd; Maserati logo and model designations are registered trademarks of exclusive propriety of Maserati S.p.A. under license of Maserati S.p.A All rights reserved; Bluetooth is the registered trademark of BLUETOOTH SIG, INC.; Android, Google Play are trademarks of Google Inc., App Store is a service mark of Apple Inc., The respective owners reserve the rights of their trademarks referred to in this manual.

We have attempted to include descriptions and instructions for all the functions of the Maserati MC-eScooter at the time of printing. However, due to constant improvement of product features and changes of design, your KickScooter may differ slightly from the one shown in this document. Please visit the Apple App Store (iOS) or Google Play Store (Android) to download and install the App, and visit [www.segway.com](http://www.segway.com) to download the latest user materials.

Please note that there are multiple Segway and Ninebot models with different functions, and some of the functions mentioned herein may not be applicable to your unit. The manufacturer reserves the right to change the design and functionality of the Maserati MC-eScooter product and documentation without prior notice.

© 2021 Ninebot (Beijing) Tech Co., Ltd. All rights reserved.

Maserati logo and model designations are registered trademarks of exclusive propriety of Maserati S.p.A. under license of Maserati S.p.A All rights reserved.

## 13 Contact

Contact us if you experience issues relating to riding, maintenance and safety, or errors/faults with your KickScooter.

Australia & New Zealand:

Panmi Pty Ltd.

174 Broadway, Chippendale NSW 2008

Email: [support@panmi.com.au](mailto:support@panmi.com.au)

Website: [www.panmi.com.au](http://www.panmi.com.au)

Have your KickScooter serial number on hand when contacting Segway. You can find your serial number on the underside of your KickScooter or in the App under More Settings → Basic Information.