



Ninebot eKickScooter E8/E10 User Manual



The manufacturer reserves the right to make changes to the product and update this manual at any time. Product parameters vary with different models. They are subject to change without prior notice. Visit www.segway.com to download the latest user materials.
K031P0309-A0

ninebot®

Please read the User Manual carefully and understand the assembly and usage before allowing child to ride it.
Please do not discard this manual as it is a permanent part of this product.

Contents

1. Riding Safety	01
2. Parts and Functions	03
3. Assembly	04
4. Pre-ride Checklist	05
5. Learn to Ride	05
6. Warnings and Cautions	08
7. Folding and Unfolding	09
8. How to Charge	10
9. Specifications	11
10. Maintenance	12
11. Certifications	14
12. Trademark and Legal Statement	15
13. Contact	16

Original instructions

Welcome

Thanks for choosing the Ninebot eKickScooter (hereinafter referred to as the scooter)! The scooter is especially designed for smooth and safe riding. It combines the power of electricity and the style of a traditional scooter. Enjoy an effortless gliding experience on this cool, ultra-lightweight, and easy to fold scooter.

Before you start, make sure the rider meets the age, height and weight requirements below.

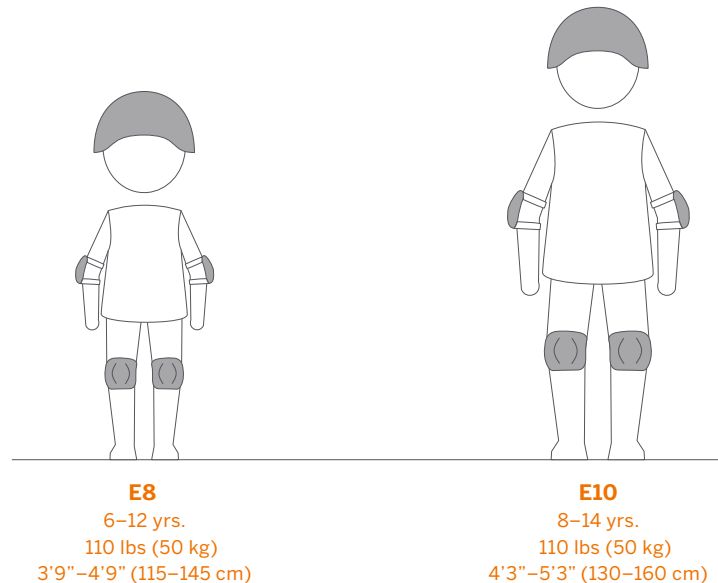

⚠ WARNING

Protective equipment should be worn.
Not for children with a body mass of more than 50 kg.
To reduce the risk of injury, adult supervision is required.

1. Riding Safety

Remember that whenever you ride the scooter, you risk injury from loss of control, collisions, and falls. To reduce the risk, you must read and follow all "CAUTION" and "⚠️ WARNING" notices. Please understand that you can reduce the risk by following the instructions and warnings in this manual, but you cannot eliminate all the risks. Please use common sense when riding.

1. The product is for recreation only. It is not intended for transportation. In order to master riding skills, the rider needs to practice. Use with caution since skill is required to avoid falls or collisions causing injury to the user or third parties. Neither Ninebot Inc., which means Ninebot (Beijing) Tech Co., Ltd. and its subsidiaries and affiliates nor Segway Inc. is responsible for any injuries, damages or legal disputes caused by a rider's inexperience or failure to follow the instructions in this manual.
2. When entering public places, always comply with the local laws and regulations. In places without laws, comply with the safety guidelines outlined in this manual.
3. DO NOT allow anyone to ride the scooter on his/her own unless he/she, and the supervising adults have carefully read this manual. The safety of a new rider is your responsibility. Assist new riders until they are comfortable with the basic operation of the scooter. Make sure each new rider wears a helmet and other protective gear.
4. Do not modify the scooter or change parts by yourself. Use only Ninebot or Segway approved parts and accessories. Modifications to your scooter could interfere with its operations, result in serious injury and/or damage, or void the Limited Warranty.
5. This product must be assembled and adjusted ONLY by adults. The scooter contains small parts which can pose a choking hazard. Keep plastic covering away from children to avoid suffocation. Children should not play with the scooter or spare parts of it, nor should cleaning, maintenance, folding and charging be done by children.

Riding Surfaces and Environment:

- This scooter is designed for riding on flat, dry paved surfaces. Ride in an open outdoor space. Make sure there are no pedestrians, skateboards, bikes, scooters and other riders in your surroundings.
- Never use in roadways, near motor vehicles, near steep inclines or steps, swimming pools or other bodies of water. Avoid construction sites, sudden surface changes, drainage grates, potholes, cracks, hydrants, parked cars, speed bumps and other obstacles. Don't ride on loose grounds (such as rocks, gravel or sand).
- Do not ride in the snow or in the rain. Submersion in water may cause the battery to damage, catch fire or even explode.
- Do not ride in extreme temperature conditions or in low visibility, such as at dawn/dusk or at night.

When Riding:

- Always wear a helmet and other protective gear when riding the scooter. Use an approved bicycle or skateboard helmet that fits properly with the chin strap in place, and provides protection for the back of your head.

⚠️ WARNING

Protective equipment should be worn. Not to be used in traffic.
Never hitch a ride with another vehicle.

- DO NOT bypass. Slow down when entering unfamiliar areas. Use caution when riding in areas with trees, posts, or fences. Always slow down when turning.
- Be alert and aware of the surroundings both far ahead and in front of you when riding. Your eyes are your best tool for safely avoiding obstacles and low traction surfaces (including, but not limited to, wet ground, loose sand, loose gravel, and ice).
- Avoid sudden acceleration and deceleration. Never ride faster than the designed top speed (the top speed can be affected by rider weight, battery level, incline, etc.). As with other vehicles, faster speeds require longer braking distance. Sudden braking on low traction surfaces could lead to wheel slip or falls. Be cautious and always keep a safe distance between you and others when riding.
- Keep both hands on the handlebar and do not carry cargo of any kind. DO NOT use a cell phone, camera, headphones, ear buds or perform any other activities while riding.
- Do not touch moving or spinning wheels. Keep your hair, clothing, or similar articles from coming in contact with the moving parts.

⚠️ WARNING

If the scooter makes abnormal sound or signals an alarm, stop riding immediately.

Who Should Not Ride:

- I. Anyone under the influence of alcohol, drugs, or intoxicants.
- II. Anyone who suffers from diseases (especially in the head, heart, back and neck) that put them at risk if they engage in strenuous physical activity.
- III. Anyone who has a health condition that would interfere with their ability to maintain balance.
- IV. Anyone whose age, height and weight is outside the stated limits.
- V. Those with compromised mental abilities who cannot understand the risks and proper operation of the vehicle.

⚠️ WARNING

This scooter is unsuitable for children under 6 years due to its maximum speed.

Safe Use:

- Do not ride the scooter when the ambient temperature exceeds the operating temperature of the product (see Specifications), because low/high temperatures can decrease vehicle performance and even lead to accidents.
- Always park with the kickstand on a flat and stable surface. Once the scooter is on its stand, check its stability to avoid any risk of falling (by slip, wind or slight jolt). Do not park in a busy area, but rather along a wall.
- It is recommended to conduct regular maintenance of the scooter (see Maintenance).
- Please read the User Manual before charging the battery (see How to Charge).

⚠️ WARNING

Only use the charger specified by the manufacturer. Only use the battery supplied by the manufacturer.

- Never allow your child to touch any vehicle parts with gaps such as the folding mechanism, fender brake, wheels, the brake system, etc. Do not touch the brake or hub motor after riding, so as to avoid burns due to increased temperature.

2. Parts and Functions

Please familiarize yourself with each part. The pictures shown are for illustration purpose only. Actual product may vary.

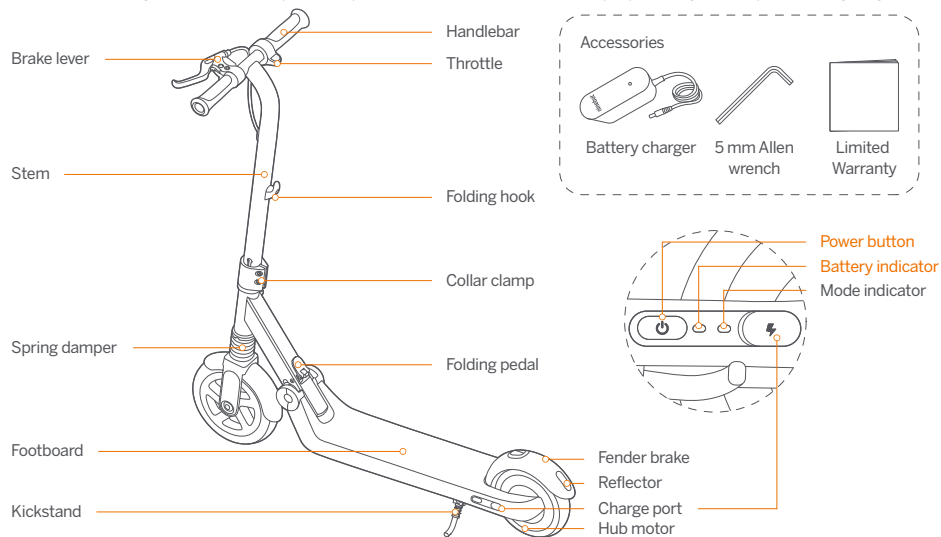

Power button

Press the button to power on or change riding modes. The Turbo mode is set as default when turned on. Hold for 2s to power off.

		Turbo mode	Cruise mode	Safe mode
Max. speed	E8	8.7 mph (14 km/h)	8.7 mph (14 km/h)	6.2 mph (10 km/h)
	E10	10 mph (16 km/h)	10 mph (16 km/h)	6.2 mph (10 km/h)
Mode indicator		solid, with 1 beep	blink slowly, with 2 beeps	blink fast, with 3 beeps
Ambient light (for E10 only)		full-colour breathing	blue breathing	red breathing

Battery indicator

The colour indicates the battery level: 50% green, 20%–50% yellow, 20% red.

*When an abnormality occurs, both the battery and mode indicators will flash and an alarm will start beeping.

3. Assembly

1 Slightly loosen the bolts on the collar clamp.

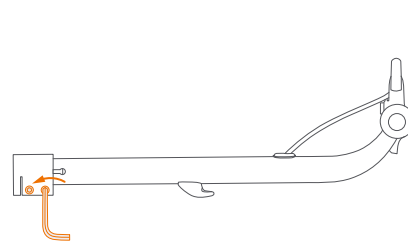

2 Slide the stem in to the marked length.

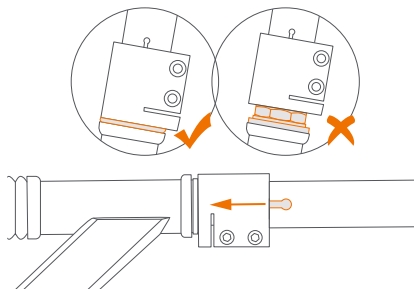

3 Park with the kickstand. Step on the footboard, hold the handlebar and push forward to unfold the scooter.

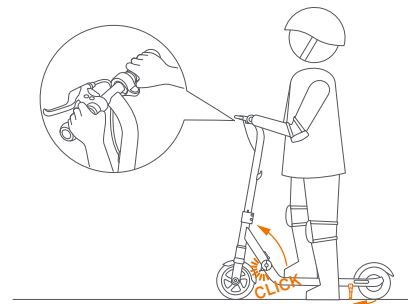

4 Tighten the bolts on the collar clamp. Torque: about 8.9 ft-lb (12.0 1.0 N•m)

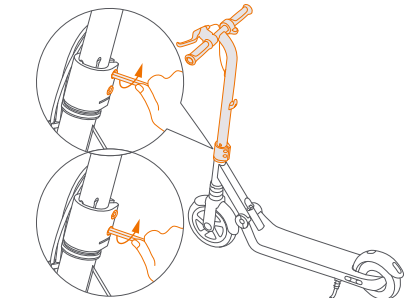

⚠ WARNING

Power off the scooter before assembling. The brake cable should not wrap around the stem.

CAUTION

When not properly tightened, the handlebar will rotate out of alignment and cause accidents.

4. Pre-ride Checklist

- ✓ Make sure there are no loose fasteners and damaged components. Check all functional parts like the frame, handlebar, tires and make sure the steering system is well adjusted. Ensure that all locking devices are engaged.
- ✓ Check the brake for proper function. When you squeeze the brake lever or stamp on the fender brake, there should be positive braking action.
- ✓ Battery: if the battery level is low (battery indicator is red), please fully charge the battery to ensure normal riding.
- ✓ Always wear a helmet and protective equipment like knee pads and elbow pads. Always wear shoes and proper outfit (sports shoes and clothes are recommended). Never ride barefoot or in sandals. Long hair should be tied back to prevent it from blocking your vision.
- ✓ Do not attempt your first ride in any area where you might encounter children, pedestrians, pets, vehicles, bicycles, or other obstacles and potential hazards.
- ✓ Check and obey local traffic laws and regulations for scooters.

CAUTION

If you have any concern over the safety of the product and/or there is symptom of abnormality, please stop using the product immediately and contact the customer service for support.

5. Learn to Ride

⚠ WARNING

Always wear a helmet and other protective gear like gloves, knee pads and elbow pads, to minimize any possible injury in the learning process. To reduce the risk of injury, adult supervision is required.

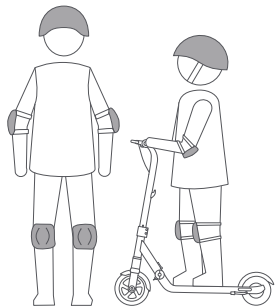

- 1 Turn on the scooter. If the battery indicator is red, please charge immediately (see How to Charge).

CAUTION

For the safety of the rider, please ride in Safe mode (see details on page 03) until the rider is comfortable enough to use Turbo mode.

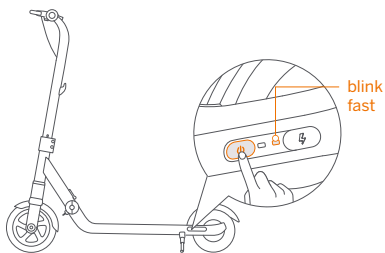

- 2 Hold the handlebar firmly with both hands. Place one foot on the footboard and start kicking with the other foot.

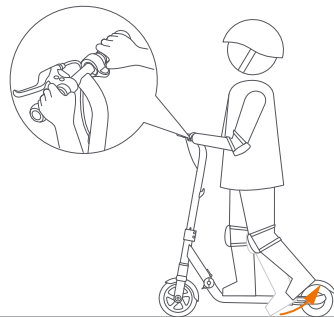

- 3 When the scooter starts cruising, place both feet on the footboard and keep your balance.



- 4 Accelerate and Decelerate

	Cruise mode	Turbo mode	Safe mode
How to accelerate	kick to go	press the throttle lightly	
How to decelerate	squeeze the brake lever and/or step on the fender brake		release the throttle, squeeze the brake lever and/or step on the fender brake

Accelerate



Cruise mode

NOTE: The maximum speed is 6.2 mph (10 km/h) within 0.6 mi (1 km) mileage.

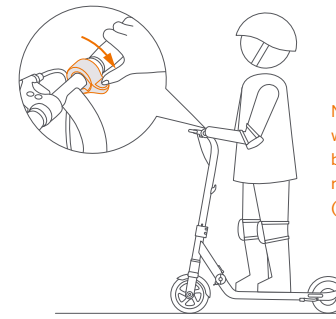

Turbo mode/ Safe mode

NOTE: The motor will not engage before the speed reaches 1.9 mph (3 km/h).

Decelerate

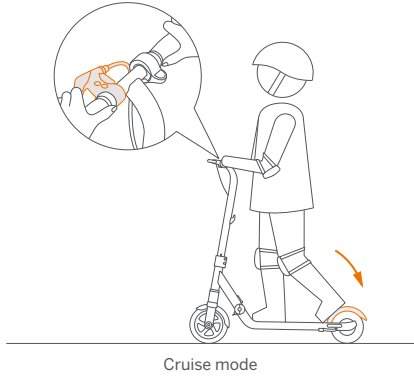

Cruise mode

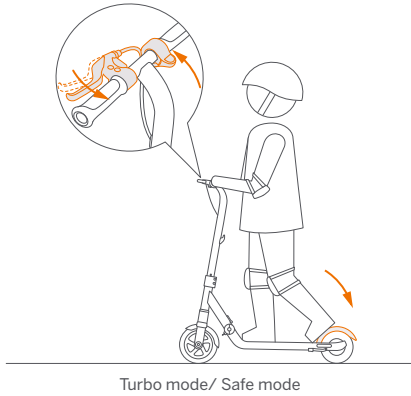

Turbo mode/ Safe mode

⚠ WARNING

Stay alert and avoid abrupt acceleration or deceleration. Otherwise you risk serious injury due to imbalance, loss of traction and falls. DO NOT perform stunts of any kind. Both tyres must remain on the ground at all times.

5 To turn, shift your body and turn the handlebar slightly.

6 When the scooter has stopped cruising, step off one foot at a time. Be extra cautious when dismounting for the first time.

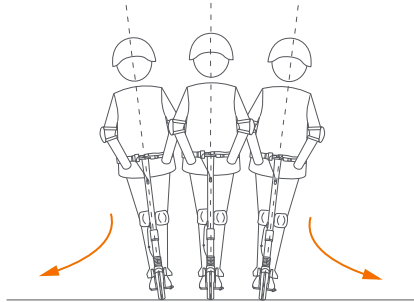

6. Warnings and Cautions

⚠ WARNING

Failure to follow these instructions could lead to serious injuries. Parents or carers must supervise the rider for the whole ride. Make sure you and your child understand all the warnings and safety cautions.

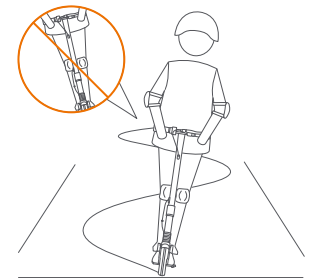
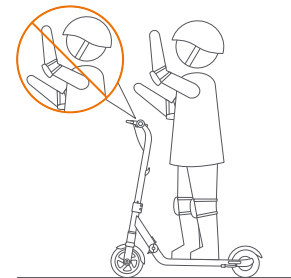
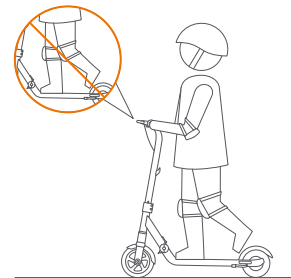
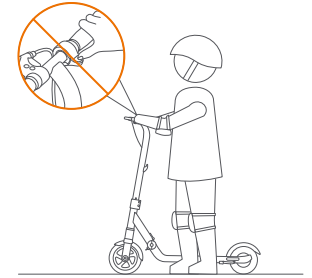
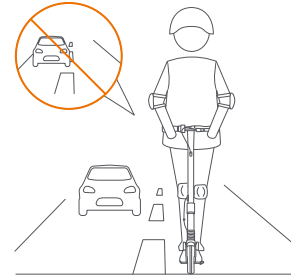



! DO NOT ride in the rain. If there is a puddle, please circle around it at a low speed.

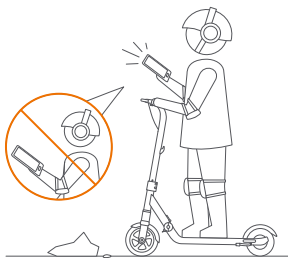

! Stay alert and DO NOT perform any other activities while riding.

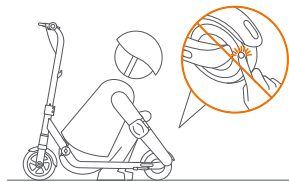

! To avoid pinching, DO NOT touch parts with gap.

7. Folding and Unfolding

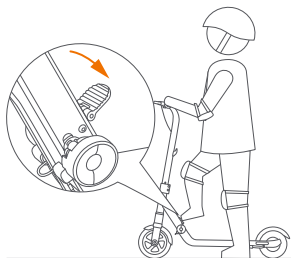

How to fold:

1. Turn off the scooter and flip down the folding pedal.
2. Hold the handlebar with both hands and step on the folding pedal.

CAUTION

Do not step on the folding pedal while standing on the footboard.

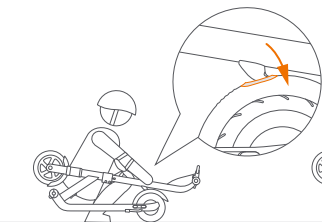

3. Fold the stem down until the folding hook locks into the fender brake.
*Lift the stem to make sure it's securely folded.

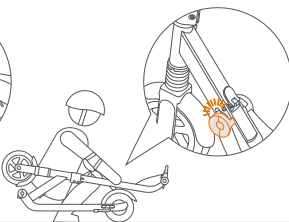

Unfold the scooter:

1. Press the fender brake to disengage the hook.
2. Unfold the stem and push it up until you hear a click. *Confirm that the latching axis on the folding mechanism is secured.
3. Flip up the folding pedal after unfolding.

8. How to Charge

CAUTION

The charger is not a toy. Children should not be allowed to touch the charging device. Before and during charging, make sure the scooter is turned off.

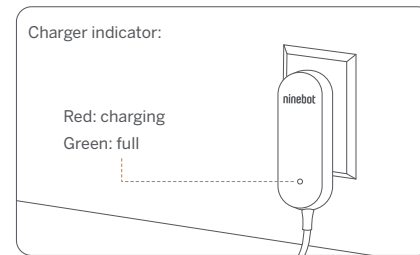
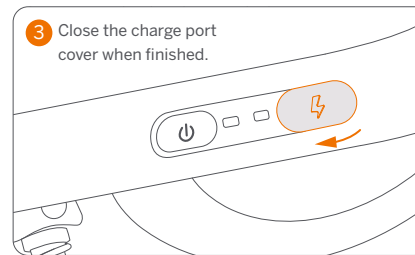
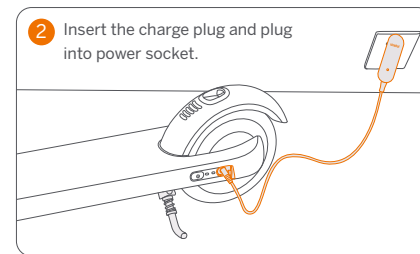
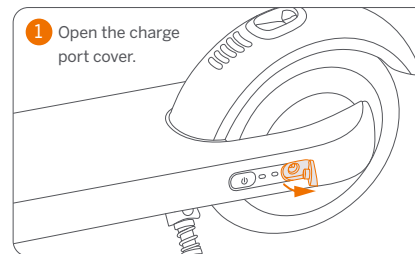

! WARNING:

- Use only the charger specified by the manufacturer. Other types can burst and catch fire.
- Do not attempt to charge your scooter if it, the charger, or the power outlet is wet.
- When there is abnormal smell, sound or light display, stop charging immediately and contact after-sales service.
- Keep away from inflammable and explosive materials when charging, and place the scooter in a place out of the reach of children.
- When not charging, disconnect the charger from the power socket.

9. Specifications

	Item	E8	E10
Weight and Size	Net Weight	Approx. 17.6 lbs (8.0 kg)	Approx. 18.7 lbs (8.5 kg)
	Length × Width × Height	Approx. 32.7 × 13.2 × 33.5 in (830 × 335 × 850 mm)	Approx. 36.0 × 15.7 × 37.4 in (915 × 400 × 950 mm)
	Folded (Length × Width × Height)	Approx. 34.4 × 13.2 × 12.6 in (875 × 335 × 320 mm)	Approx. 38.6 × 15.7 × 12.6 in (980 × 400 × 320 mm)
Rider Requirement	Payload	44–110 lbs (20–50 kg)	
	Recommended Age	6–12 yrs.	8–14 yrs.
	Recommended Height	3'9"–4'9" (115–145 cm)	4'3"–5'3" (130–160 cm)
Vehicle Parameters	Riding Mode	Turbo mode, Cruise mode and Safe mode	
	Max. Speed	8.7 mph (14 km/h)	10 mph (16 km/h)
	Typical Range ^[1]	Approx. 6.2 miles (10 km); 40 minutes	
	Max. Slope	Approx. 7%	
	Traversable Terrain	Flat surface, paved road; obstacles < 0.4 in (1 cm); gaps < 1.2 in (3 cm)	
	Operating Temperature	14–104°F (-10–40°C)	
	Storage Temperature	-4–122°F (-20–50°C); 41–86°F (5–30°C) recommended	
	IP Rating	Vehicle IPX4	
Battery Pack	Charging Time	Approx. 4 h	
	Battery Type	Lithium-ion battery	
	Nominal Voltage	21.6V ---	
	Max. Charging Voltage	25.2V ---	
	Charging Temperature	32–104°F (0–40°C); 50–95°F (10–35°C) recommended	
	Nominal Capacity / Energy	2550 mAh / 55.08 Wh	
Battery Management System	Over-heating, short circuit, over-current and over-charge protection		
	Battery Management System		
Battery Charger	Input Voltage	100–240 V~	
	Output Voltage	25.2 V---	
	Output Current	0.8 A	
	Output Power	20.16 W (0.02 kW)	
Motor	Max. Power	200 W (0.2 kW)	
	Nominal Power	130 W (0.13 kW)	150 W (0.15 kW)

	Item	E8	E10
Others	Braking Method	Regenerative brake + hand-operated brake + foot brake	
	Tyres	Tubeless tyre; material: synthetic rubber	
	Battery Indicator	RG LED light	
	Mode Indicator	White LED light	
	Frame Material	Aluminum-alloy	
	Shock Absorber	Spring damper	

[1] Typical Range: tested while riding with full battery, 110 lbs (50 kg) load, 77°F (25°C), 60% of max. speed on average on pavement.

* Some of the factors that affect range include: rider weight, number of starts and stops, ambient temperature, etc.

10. Maintenance

Maintenance should be carried out by an adult regularly.

⚠ WARNING

Do not dispose of this product in a landfill, by incineration, or by mixing with household trash. Serious danger/injury can occur because of the electrical components.

Cleaning

Use a soft and wet cloth to clean. Stains hard to remove can be scrubbed with a toothbrush and toothpaste, then wiped off with a soft and wet cloth.

CAUTION

Do not wash your scooter with alcohol, gasoline, acetone, or other corrosive/volatile solvents. These substances may damage the appearance and internal structure of your scooter. Do not wash your scooter with a power washer or hose.

⚠ WARNING

Before cleaning, make sure the scooter is powered off, the power cord is unplugged, and the rubber cap on the charge port is tightly sealed; otherwise you may damage the electrical components.

Storage

- Before storage, please turn off the scooter and fully charge it to avoid over-discharge, which will cause permanent damage. Charge the scooter every 30–60 days for long-time storage.
- Store in a cool and dry place indoors. Exposure to sunlight and temperature extremes (both hot and cold) will accelerate the aging process of the vehicle components and may permanently damage the battery. If the temperature of the storage environment is lower than 32°F (0°C), do not charge it until after placing it in a warm environment, preferably over 50°F (10°C).

- Do not store in a dusty environment, otherwise the electrical components may be damaged. Do not store where the scooter may be eroded by chemicals.

⚠ WARNING

- Prolonged exposure to UV rays, rain and the elements may damage the enclosure materials.
- Store indoors when not in use.
- Keep away from fire!

Battery

A well-maintained battery can perform well even after many miles of riding. Charge the battery after each ride and avoid draining the battery. When at 72°F (22°C), the battery performance is at its best and the vehicle can achieve a longer range. Electronics inside the battery record the charge-discharge condition of the battery; damage caused by over-charging or over-discharge will not be covered by the Limited Warranty.

⚠ WARNING

- For information about battery and electrical waste, please contact your household waste disposal service, your local or regional waste management office, or your point-of-sale.
- Do not attempt to replace or disassemble the battery. Do not dismantle or puncture the casing. Keep away from metal objects to prevent short circuit.
- Risk of fire and electric shock. No user serviceable parts.
- Do not store or charge the battery at temperatures outside the stated limits (see Specifications).
- Never charge in areas forbidden by law.

Battery Charger

- Regularly examine the charger for damage to the cord, plug, enclosure and other parts. If any damage is found, stop using until it is repaired or replaced.
- The external cable of the charger (power supply unit) cannot be replaced; if the cord is damaged, the transformer must be discarded and replaced by a new one.

Cable Tension Adjustment

When the brake is too tight or loose, you can thread in/out the brake cable adjuster.

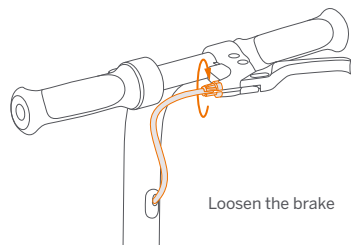
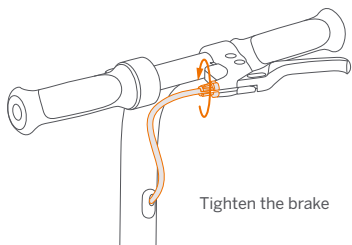

Others

- Before lifting, moving, or otherwise transporting the scooter, turn it off and fold the scooter. Handle with care and avoid violent force, such as throwing and heavy pressure. Keep away from fire and water.
- Tyres supplied with the product are to be mounted on the wheel by a professional repairer. Removing the wheels is complicated and incorrect assembly can lead to instability and malfunctions.

In case of accidents or breakdown, contact an authorized repairer if the product is still under warranty. If it's not, you can contact any specialized repairer of your choice. You can ask for the list of the authorized repairers from the customer service available at www.segway.com.

Efforts have been made to simplify wording in the user manual for users. Where an action appears too complicated for a user, he/she is advised to contact an authorized or a specialized repairer or customer service.

NOTICE: INSURANCE

YOUR INSURANCE POLICIES MAY NOT PROVIDE COVERAGE FOR ACCIDENTS INVOLVING THE USE OF THIS SCOOTER. TO DETERMINE IF COVERAGE IS PROVIDED, PLEASE CONTACT YOUR INSURANCE COMPANY OR AGENT.

11. Certifications

For Model: E8, E10

This product is certified to ANSI/CAN/UL-2272 by UL

The battery complies with UN/DOT 38.3.

European Union Compliance Statement

Important WEEE information



WEEE Disposal and Recycling Information Correct Disposal of this product. This marking indicates that this product should not be disposed with other household wastes throughout the EU.

To prevent possible harm to the environment or human health from uncontrolled waste disposal, recycle it responsibly to promote the sustainable reuse of materials resources. To return your used device, please use the return and collection systems or contact the retailer where the product was purchased. They can take this product for environmental safe recycling.

Battery recycling information for the European Union



Batteries or packaging for batteries are labeled in accordance with European Directive 2006/66/EC and amendment 2013/56/EU concerning batteries and accumulators and waste batteries and accumulators. The Directive determines the framework for the return and recycling of used batteries and accumulators as applicable throughout the European Union. This label is applied to various batteries to indicate that the battery is not to be thrown away, but rather reclaimed upon end of life per this Directive.

In accordance with the European Directive 2006/66/EC and amendment 2013/56/EU, batteries and accumulators are labeled to indicate that they are to be collected separately and recycled at end of life. The label on the battery may also include a chemical symbol for the metal concerned in the battery (Pb for lead, Hg for mercury, and Cd for cadmium). Users of batteries and accumulators must not dispose of batteries and accumulators as unsorted municipal waste, but use the collection framework available to customers for the return, recycling, and treatment of batteries and accumulators. Customer participation is important to minimize any potential effects of batteries and accumulators on the environment and human health due to the potential presence of hazardous substances.

Before placing electrical and electronic equipment (EEE) in the waste collection stream or in waste collection facilities, the end user of equipment containing batteries and/or accumulators must remove those batteries and accumulators for separate collection.

Restriction of Hazardous Substances (RoHS) Directive

This Ninebot (Changzhou) Tech Co., Ltd. product, with included parts (cables, cords, and so on) meets the requirements of Directive 2011/65/EU on the restriction of the use of certain hazardous substances in electrical and electronic equipment ("RoHS recast" or "RoHS 2").

Electromagnetic Compatibility

Ninebot (Changzhou) Tech Co., Ltd. hereby declares that this device complies with the essential requirements and other relevant provisions of the Electromagnetic Compatibility 2014/30/EU, the Machinery Directive 2006/42/EC and the RoHS directive 2011/65/EU.

The declaration of conformity can be viewed at the following address: <http://eu-en.segway.com/support-instructions>



Segway Europe BV,
EU Representative: Hogehilweg 8-6th floor 1101 CC Amsterdam The Netherlands

Hereby, Ninebot (Changzhou) Tech Co., Ltd. declares that the equipment listed in this section are in compliance with the essential requirements and other relevant provisions of the Electromagnetic Compatibility 2014/30/EU.

12. Trademark and Legal Statements

Ninebot is the registered trademark of Ninebot (Tianjin) Tech. Co., Ltd; Segway and the Rider Design are the registered trademarks of Segway Inc.; The respective owners reserve the rights of their trademarks referred to in this manual.

We have attempted to include description and instructions for all the functions of the Ninebot eKickScooter at the time of printing. However, due to constant improvement of product features and changes of design, your scooter may differ slightly from the one shown in this document.

Please note that there are multiple Segway and Ninebot models with different functions, and some of the functions mentioned herein may not applicable to your unit. The manufacturer reserves the right to change the design and functionality of the scooter product and documentation without prior notice.

©2020 Ninebot (Beijing) Tech Co., Ltd. All rights reserved.

13. Contact

Contact us if you experience issues relating to riding, maintenance and safety, or errors/faults with your scooter.

Asia Pacific

China Mainland: Ninebot (Beijing) Tech Co., Ltd.

Room B201, B202, B6 Bldg. Zhongguancun Dongsheng Technology Park (Northern Territory), No. 66, Xixiaokou Rd, Haidian Dist., Beijing, China.

Tel: 400-607-0001/86-10-8482-8002

E-mail: apac_sales@ninebot.com

South Korea: Segwayseoul Inc.

Room 605-606,80, Jomaru-ro 385beon-gil, Bucheon-si, Gyeonggi-do, Republic of Korea.

Tel: 82-70-4068-8002

E-mail: korea-service@ninebot.com

Have your scooter serial number on hand when contacting Segway.

You can find the serial number on the underside of your scooter.